

ROBAM



User Manual

Before operating this unit, please read the user manual completely and keep it. If the manual is lost, you can send e-mail to overseas@robam.com, request for an electronic manual.

CXW-220-A817

CXW-220-A815

Range Hood

CONTENTS

Safety Precaution.....	1
Important Information.....	4
Product Overview.....	5
Packing List.....	5
Installation	6
User Manual.....	9
Maintenance.....	9
Removal of Components.....	10
Circuit Diagram.....	12
Troubleshooting of General faults.....	13

Dear users:



Thank for your buying our range hood. Please accept our best regards. Please read this user manual carefully before installation and operation.

*The pictures in this manual only for your reference. If the picture isn't accord with object, subject to object. We keep to right to update appearance, structure or products without notice.

Safety Precaution

In order to avoid harm or property damage to the users or other person, the following distinction and marks are stipulated. They are important safety precaution, please comply strictly based on the full understanding.

Subject to harmful or destruct degree





 Danger	If ignore this sign and operate product improperly, it's highly possible to cause danger, serious injury or fire.
 Warning	If ignore this sign and operate product improperly, it's possible to cause danger, serious injury or fire.
 Notice	If ignore this sign and operate product improperly, it's possible to cause injury or loss.

Notice and Prohibit Mark



 Prohibit	 Prohibit Flame	 Prohibit Touch	 Prohibit Touch by Wet Hand	 Prohibit Disassembly	 Strict Execution	 Necessary Earthed	 Caution Electric Shock	 Caution Scald
---	--	--	--	--	--	--	--	---

 Warning Please use this product according to manual strictly, or ROBAM shall not take any responsible caused by improper operation.







Danger

 Prohibit	Don't allow children or weakling to use range hood separately, or it may cause electric shock or other accident.
 Prohibit	Prohibit water on motor, switches or other electric parts; Prohibit wash range hood by water spray. Don't use range hood if wet or it may cause electric leakage or shock.
 Prohibit	Don't change, stretch, bind or press electric wire, or it's possible to cause electric shock or fire because of broken wire.
 Prohibit	Prohibit any change of interior circuit, or it may cause injury or other danger, for example, electric shock or fire.
 Prohibit Touch by Wet Hand	Don't touch plug, electric parts or button by wet hands, or it may cause electric shock.









Danger

 Strict Execution	<p>Unplug before cleaning, installing or maintaining, avoiding from electric shock.</p>
 Strict Execution	<p>Please turn off range hood immediately if pan got fire (range hood shall aggravate fire if it's working) and extinguish fire by effective action. For example, cover flame by metal cover, turn off gas valve immediately and remove inflammable things.</p>
 Strict Execution	<p>Any abnormal, please turn off power, take off plug or cut off electric source, and contact service. It's possible to cause electric shock or fire if using range hood under abnormal situation.</p>



Warning

 Prohibit Disassembly	<p>Range hood must be installed, disassembled or maintained by professional person.</p>
 Prohibit	<p>Stove fire shall be extinguished timely when it is not used; do not flambe under the range hood and it's prohibited to bake food under range hood directly to prevent range hood from damaging and causing accidents.</p>
 Prohibit Touch	<p>Don't touch bulb if it's on or just close in short time, or it may cause scald.</p>
 Strict Execution	<p>In order to ensure safety, range hood must be installed by specific accessory (especially expansion pipe and wooden screws, or it may cause accidental drop of range hood). The pipe bore and hole must fit tightly during the installation of metal expansion pipe. It is prohibited to make excessively large hole to prevent accidental drop of loosening expansion pipe.</p>
 Strict Execution	<p>The range hood must be used by specific plug and properly ground it. It's possible to cause electric shock, hot plug or fire because of improper electric wire. Installation must be executed by professional person based on local electrical regulations. Before connect electricity, power must be turned off.</p>
 Strict Execution	<p>If the supply cord is damaged, it must be replaced by the manufacturer, its service agent or similarly qualified persons in order to avoid a hazard.</p>







 **Warning**

 Strict Execution	All operation must comply with our safety guidelines as well as local safety regulations.
 Strict Execution	There shall be adequate ventilation of the room when the range hood is used at the same time as appliances burning gas or other fuels.
 Strict Execution	This appliance just for household use only. And it's not allowed to exhaust dangerous or explosive matter or air. It should be put under dry and ventilation environment without dangerous air.
 Strict Execution	The range hood and electric circuit must be installed by skilled and trained personnel with required qualification. When installation, the related regulation, standard or instruction on fire must be complied. It may cause danger because of improper installation, for example, electric shock, drop or fire accident.
 Strict Execution	The outlet must be connect with outside. In order to ensure safety and fresh air, waste gas should be exhaust to outside. Don't exhaust waste gas to the wall, loft or garage.
 Strict Execution	There is a fire risk if cleaning is not carried out in accordance with the instructions.
 Strict Execution	Keep a good habit to turn off gas hob and gas valve if go outside, sleep or finish operation. Replace or check gas pipe regularly, since gas alarm device can't completely avoid accident caused by gas leakage.
 Strict Execution	Accessible parts may become hot when used with cooking appliances.

 **Notice**

 Prohibit	The air must not be discharged into a flue that is used for exhausting fumes from appliances burning gas or other fuels, the discharge of air must fulfill the requirements of local regulations.
 Strict Execution	Before removing range hood for installation, clean or maintainance, power must be cut off avoiding from electric shock. When installation, clean or maintainance, protective gloove must be wear avoiding from injury.
 Strict Execution	The temperature for range hood working can't exceed 40°C.

Notice

 Strict Execution	<p>Because the installation is difficult and hood is heavy, the installation shall be executed by professional person based on manual.</p>
 Strict Execution	<p>Don't break electric wire or other invisible equipment when cutting something or drilling holes on ceiling.</p>
 Strict Execution	<p>When range hood is using in well sealed building, it should have air inlet or open door to ensure good ventilation.</p>
 Strict Execution	<p>When the oil exceeds 2/3 or near tick mark in the oil cup, clean it in time. Don't eat waste oil from oil cup.</p>
 Strict Execution	<p>The wall of installing range hood needs enough strength. For hollow walls, the thickness of solid layer of hollow wall must be more than 30mm, but for concrete walls, it can be drill holes directly. The range hood must be fixed on the wall firmly.</p>
 Strict Execution	<p>This appliance is not intended for use by persons (including children) with reduced physical, sensory or mental capabilities, or lack of experience and knowledge, unless they have been given supervision or instruction concerning use of the appliance by a person responsible for their safety. Children should be supervised to ensure that they do not play with the appliance.</p>
	<p>DISPOSAL: Do not dispose this product as unsorted municipal waste. Collection of such waste separately for special treatment is necessary. This product must not be disposed together with the domestic waste. This product has to be disposed at an authorized place for recycling of electrical and electronic appliances. By collecting and recycling waste, you help save natural resources, and make sure the product is disposed in an environmental friendly and healthy way.</p>

Important Information

Package of Range Hood

Please settle those packages carefully in order to protect environment. Don't allow children to play plastic film and package, it may cause asphyxia. Please avoid children near package material.

Before use Range hood

This range hood exhaust fume outside. Please read this manual and all information carefully before installation and operation. Please comply with our suggestion. If it's necessary, please read manual for gas hob. And please keep these manual carefully for future reference. If range hood has obvious damage, please don't electrify and contact operator.

Product Overview

Technical Specification

Model	CXW-220-A817 CXW-220-A815	Noise	≤58dB
		Rated Power Input	A817:222W A815:224W
Power Supply	220-240V~ 50Hz	Rated Main Motor Power Input	220W
Total Pressure Efficiency	≥22%	Lamp Power (max)	A817:≤2W A815:≤2W × 2
Nominal Wind Pressure	220Pa		Dimension (L×W×H)
Airflow	18m ³ /min	Net Weight	
Max static pressure	340Pa	Grease Absorption Factor	≥92%
Normal Odour Reduction Factor	≥98%		
Instantaneous Odour Reduction Factor	≥76%		

Note: 1. The deviation between the expressed value and measured value of airflow, max static pressure and nominal wind pressure shall not exceed -10% of the expressed value.

2. When turbo function is enabled, the air flow rate is 19m³/min.

Body Size

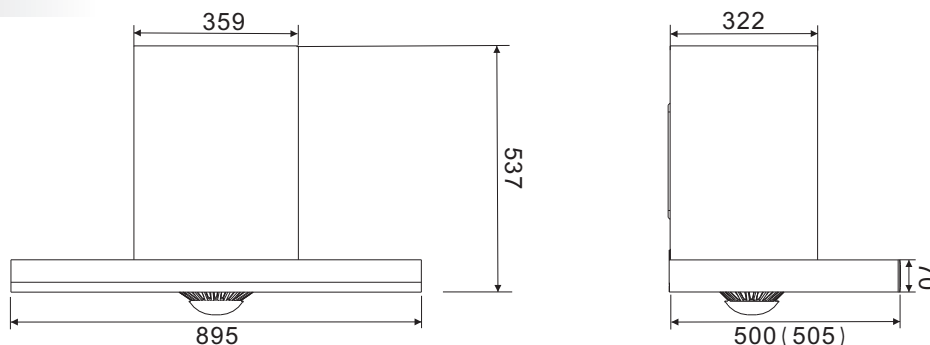

The marked sizes are for reference only. The height of drawing panel is 430, and the size in brackets is specific to A815 hood. (Unit: mm)

Packing List

Please check lists if open the package.

Packing List	No.	Name	Quantity	No.	Name	Quantity
	1	Range hood	1 piece	8	Check valve	1 set
	2	Ø185 (OD) aluminum exhaust pipe	1 set	9	ST4x18 self-tapping screw	10 piece
	3	Exhaust pipe connection		10	ST4x60 wooden screw	4 pieces
	4	Exhaust pipe fixed strip		11	Hitching foot stopper	1 piece
	5	Exhaust pipe tape		12	M6 metal expansion pipe	1 pair
	6	Plastic expansion pipe	4 pieces	13	Hitching foot	1 piece
	7	User manual	1 piece	14	Oil cup	1piece

Installation

Warning

- 1.The air must not be discharged into a flue that is used for exhausting fumes from appliances burning gas or other fuels, the discharge of air must fulfill the requirements of local regulations.
- 2.Note that when installing the metal expansion pipe, the pipe shall match with the hole in size. Overlarge hole is prohibited, as it will result in loose pipe and accidental drops.
- 3.There shall be adequate ventilation of the room when the range hood is used at the same time as appliances burning gas or other fuels.
- 4.If the flue aperture is less than air duct aperture, it will influence the fume suction effect and the too long air duct will influence the fume suction effect, too.
- 5.This appliance just for household use only.And it's not allowed to exhaust dangerous or explosive matter or air. It should be put under dry and ventilation environment without dangerous air.

Preparation for installation

●Surrounding

Keep the hood away from too many doors and windows, so as to avoid air convection affecting the efficiency.

●Tools preparation

The hood will be installed with the following tools:1. an impact drill (with drill bit) 2. a wrench 3. a screwdriver; 4. a ruler.

Notice

- Installation and circuit setting must be done by experienced professionals. Only a professionally trained person with an installation qualification can install the hood. Non-professionals are not allowed to install, dismantle and repair the hood.
- Please do not power on the hood before installation to avoid electric shock.
- Do not expose the hood if your kitchen is under renovation, because construction materials, dusts, paint, coatings, and emitted gases will corrode and tarnish the hood surface. Therefore, it is recommended to install it after the renovation is completed.
- Don't install the hood on wood and other combustible walls. The wall shall be made of noncombustible materials with enough strength and the surface shall be flat.
- The hood may have very sharp edges. So, please wear protective gloves during hood installation, cleaning or repair.
- When drilling on the wall or ceiling board, keep away from embedded wires and other concealed devices to avoid electric shock and fire.
- Do not install the hood at a too high position as well as keep the hood free from disturbance of ambient airflow lest the reduction of smoke pumping effect shall occur.
- When making cabinet, please leave space for installation and disassembly of the hood in order to maintain and overhaul the hood.
- When installing, please keep the machine body remain horizontal.
- Please use single phase grounded socket and the hood shall be well grounded (water pipe grounding is not reliable and gas pipeline grounding has risks of causing fire disaster and explosion).
- In order to ensure safety and successful installation, please use standard accessories provided with the hood for installation, otherwise the hood may be at risk of falling down.
- If the power cord is damaged, in order to avoid danger, it must be replaced by manufacturer, professionals of its maintenance department or similar departments. Please do not carry out restructuring, stretching, knotting and squeezing or apply heavy objects to the power cord, etc., otherwise it may cause power cord damage easily, leading to accidents such as electric shock and fire disaster, etc.
- After installation, please clean the surface of the hood, and then supply power for test run.

Installation

● Determine the position

The size of removable baffle (reference: 430mm) can be adjusted according to the actual situations. The installation pitch of holes is shown in Figure 2. The hood body shall be centered vertically and kept level. Ceiling hole size is shown in Figure 3.

⚠ The hood shall be installed right above the hob. The minimum distance between the bearing surface of cooking appliance and the lowest part of hood is 650mm (larger space specified in the installation instruction of gas hob shall be considered. The distance for electric cooker may be reduced appropriately, depending on the actual situations)

Note: All data units in the following figures are in mm.

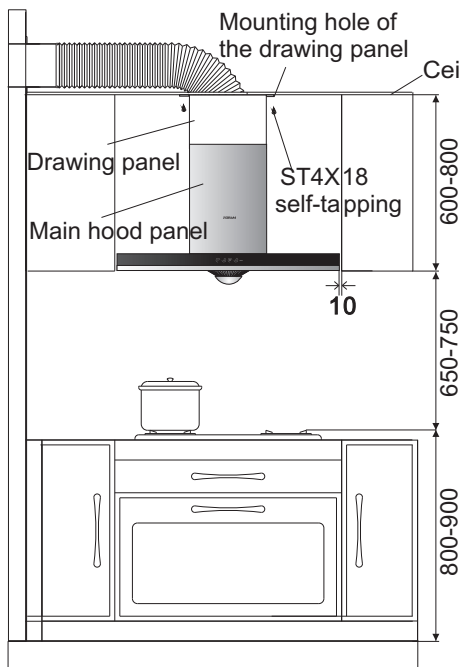

(Figure 1-1 Installation method of hood without removable baffle)

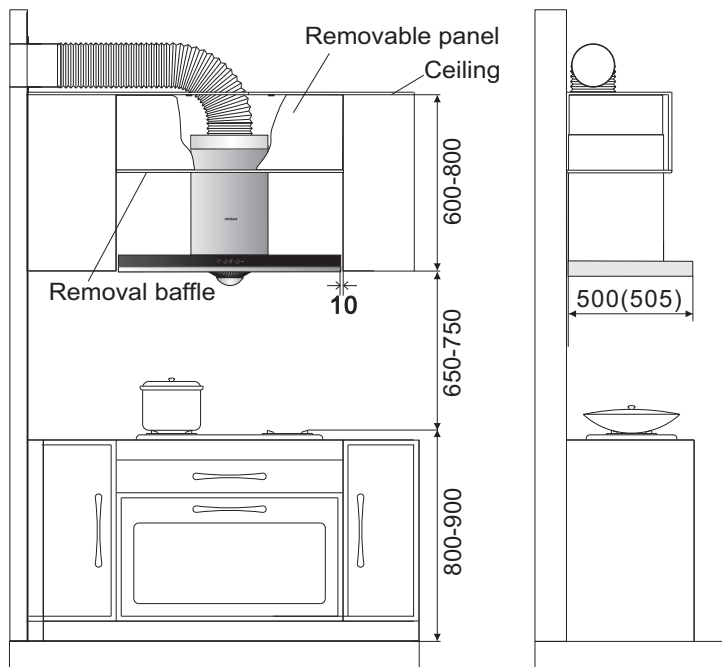

(Figure 1-2 Installation method of hood with removable baffle)
(Figures in brackets are specific to the A815 hood)

Figure 2

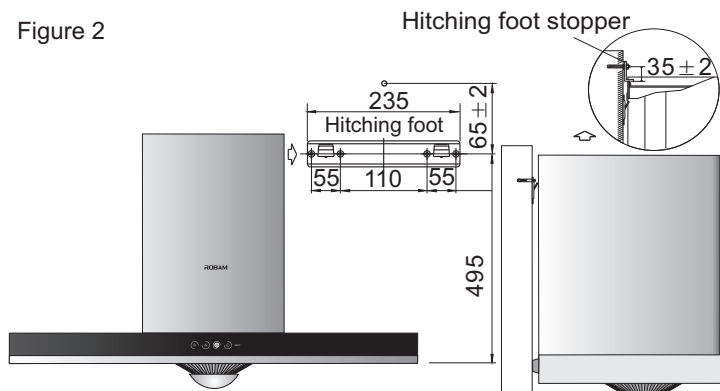

● Install hitching feet

According to the dimension of hitching feet, drill four 60-70mm deep holes (overlarge holes are prohibited) accordingly with an 8mm diameter drill bit. Press the expansion pipe into the holes, and then fix the hitching feet reliably with 4 provided ST4×60 wood screws. Drill a hole with diameter of 10mm and depth of 50-55mm at the position 65mm above the four holes and insert the M6 metal expansion pipe into the hole. (See Figure 2)

Figure 3

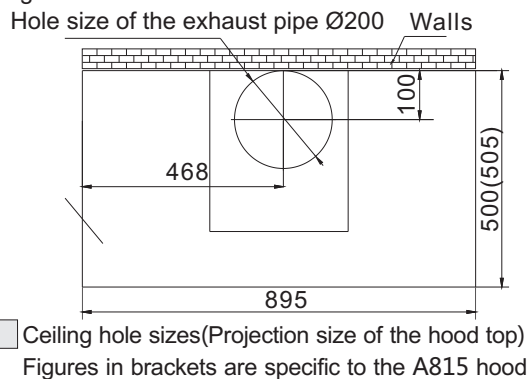

●Adjust drawing panel

Pull the two brackets of the drawing panel upwards to an appropriate height and then pull out the drawing panel by holding both sides. Remove the protective film (excluding cold plate materials) on the drawing panel and insert it along the gap between the main hood and the housing. Then adjust it to the proper height.

●Install hood body

Fix the check valve as shown in Figure 5. Then align the hanging holes in the back of hood with the hooks of hitching feet according to Figure 2, and press them together. Shake the body to check if it's hung securely. After the body is mounted, install the hitching foot stopper and gaskets to the M6 metal expansion pipe, and then tighten the nuts (to prevent accidental decoupling of the body under external force).

●Install drawing panel

As shown in Figure 1-1, there is certain gap between the drawing panel and the top plate. Push the panel against the top plate and then fix it to the top plate with ST4 × 18 screws.

(If installation method in Figure 1-2 is adopted, there's no need to adjust and install the drawing panel)

Install the aluminum foil exhaust pipe

●Drilling position of the aluminum foil exhaust pipe (public flues do not require drilling)

- Aluminum foil exhaust pipe and hob facing the window: Remove one of the glasses and install a plywood with ventilation holes or punch directly on the glass.
- Hob away from the window: Install the aluminum foil exhaust pipe through the window that is close to the hob and connected outside; or install it by punching on the wall that is close to the hob and connected outside.
- Drill hole through the wall: Determine the location of the aluminum foil exhaust pipe against the wall and draw the drilling range (i.e. a circle slightly larger than the pipe OD). Then use a long drill bit to drill through the wall. Pay attention to the wall structure and material, so as not to destroy other parts of the wall.

●Link the aluminum foil exhaust pipe

Insert the end of aluminum foil exhaust pipe without fixed strip to the pipe connection and stick with tapes. Straighten the aluminum foil exhaust pipe and then connect the pipe to the connection of public flue outlet (straighten the pipe directly to the outdoor if there is no public flue). This can be done directly when the public flue connection or wall hole is larger than the pipe. Otherwise, there are five types of pipe connection small ends (OD: 140, 150, 160, 170 and 180 respectively) to be chosen from according to the hole size. Then cut the excess part with scissors.

Then insert the end of the aluminum foil exhaust pipe with fixed strip in the outer ring of the check valve connection and seal with exhaust pipe tapes. At last, put four snaps of the check valve connection in corresponding slots, and rotate them clockwise to fix the exhaust pipe to the check valve.

Figure 4 Ø185 aluminum foil exhaust pipe

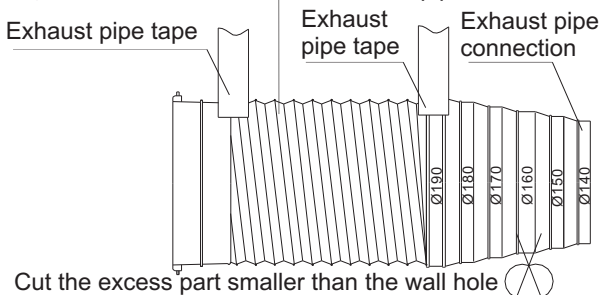

Note: During installation, straighten the aluminum foil exhaust pipe to avoid noises in semi-stretched state. Excess part may be cut with a wire cutter.

Figure 5

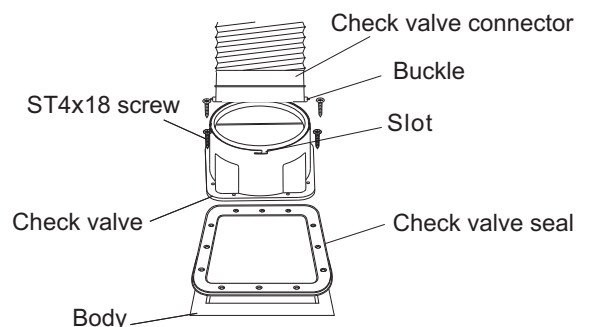



The exhaust wall hole diameter shall be close to that of the exhaust pipe, which shall not be too small. Otherwise, it will cause poor exhaust efficiency, more noises and lower airflow, etc. The connection between the pipe and the hole or the public flue must be sealed tightly to ensure that, the pipe and the check valve or public flue are connected securely. The blades at the check valve connection or public flue connection must be flexible.

User Manual

Switch Control Panel

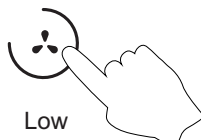

Plug in and 3 ticks from the buzzer will indicate qualified installation. Now the hood is in standby.

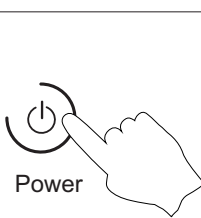
 <p>Lighting</p>	<p>Under standby mode, press the “Lighting” button once to turn on the light and repress to turn off. Each press will trigger a tick from the buzzer. The “Lighting” button only controls the light.</p>
 <p>Low</p>	<p>Under power-on mode, press the “Low” button and the impellers will rotate at low speed to inhale smoke (which shows the low level is switched on). Repress the button to turn off.</p>
 <p>Turbo/High</p>	<p>Under power-on mode, press “Turbo/High” button to enable the turbo function. When the icon twinkles, press the button again to switch to high level. In case no operation is taken after enabling the turbo function, it will switch to high level automatically after 3 minutes and the icon will stay on under high level.</p>
 <p>Power</p>	<p>Press “Power” button, the icon is on and the hood is powered on waiting for operation directions. When the “Power” icon is lit up and only the spotlight is on, press the power button gently and the spotlight will be turned off directly; if the fan is working under power-on mode, press the “Power” button, the power icon will flash and the hood will enter delayed working state, and all working state will be disabled after 1min (under delayed working state, all “Turbo/High”, “Low” and “Lighting” buttons will be disabled); When the “Power” button and all functions are shut down.</p>

Maintenance

Warning

1. There is a fire risk if cleaning is not carried out in accordance with the instructions.
2. Cleaning and maintenance shall be conducted under outage. Electrical components such as motor, switch, and connector shall not be spoiled by water so as to prevent from accidents.
3. It's prohibited to wash with water so as to prevent accidents.
4. Stove fire shall be extinguished timely when it is not used; do not flambe under the range hood and it's prohibited to bake food under range hood directly to prevent range hood from damaging and causing accidents.
5. If the supply cord is damaged, it must be replaced by the manufacturer, its service agent or similarly qualified persons in order to avoid a hazard.
6. Accessible parts may become hot when used with cooking appliances.

Notice

● The hood shall be cleaned and maintained regularly depending on the surroundings, so as to keep its cleanness & efficiency and extend its service life. We recommend that:

Clean the exhaust fume collecting hood and hood body after each cooking.

To ensure smooth discharge of fumes, the filter screen shall be cleaned regularly according to actual situations. Be careful to avoid damage when cleaning.

● It is recommended to use a neutral detergent to clean instead of strong detergents, and dry with a soft cloth, and should avoid the contact between detergent and control buttons.

● Do not allow stains to stay on the surface of the hood for too long.

● Please do not use cleaning balls, brushes and other rough objects to clean the hood to prevent the body surface from scratching.

● When cleaning or maintaining the hood, please wear protective gloves to prevent wounding during wiping.

● Please check and clean the oil cup at regular basis. When the oil reaches above 2/3 of the cup, rotate the cup rightwards with a hand to toss away the oil, as shown in right.

● Do not touch the light bulb that has been turned on or just been turned off to avoid burns.

● Please unplug it during long-term shutdown, but please do not pull hard.

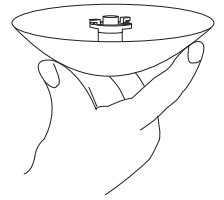

Removal of Components

⚠ Warning

1. The machine body needs not to be disassembled in ordinary conditions. Disassembly shall be operated by professional serviceman.
2. The electricity must be cut off before clean, installation or maintenance of range hood.

Note: The installation procedures are in reverse with the removal. Please wear protective gloves during operation to prevent the sharp edge of metal from hurting your hands.

Removal of light

● Removal of A817 light

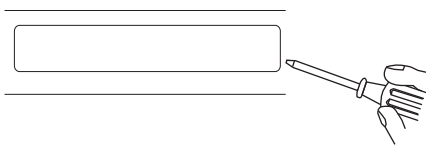

Insert a small flat head screwdriver or something sharp in the gap between the light cover and hood.

● Removal of A815 light

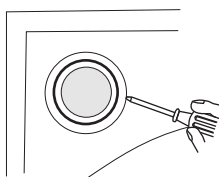

Insert a small flat head screwdriver or something sharp in the gap between the light cover and hood.

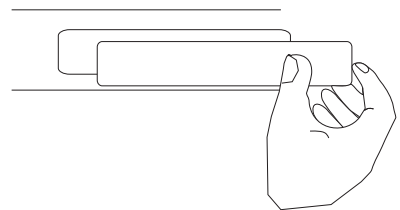

Raise the spotlight outward forcibly to remove it from the hood. Pull out the connector to replace the spotlight.

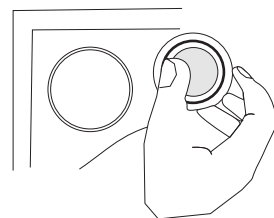

Raise the spotlight outward forcibly to remove it from the hood. Pull out the connector to replace the spotlight.

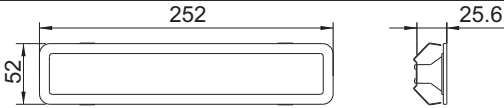
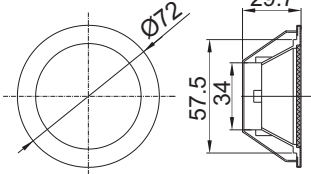
Lamp image		Lamp information	
A817		Lamp Type(A817)	Rectangular LED
A815		Lamp Type(A815)	Round LED
		Max Power	2W
		Voltage	12VDC
		Dimension	see the lamp image

Removal of switch

●Removal of A817 switch

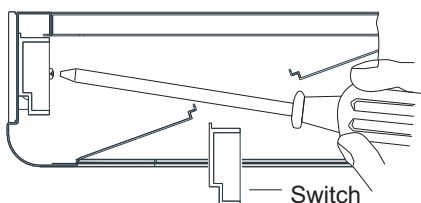

After removing the spotlight, remove the two screws on the switch with a cross screwdriver and move the switch assembly diagonally upward to take it out from the lamp hole for repair and replacement.

●Removal of A815 switch

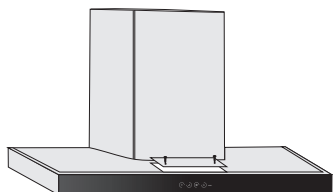

Untighten two screws on the small plate to remove the plate.

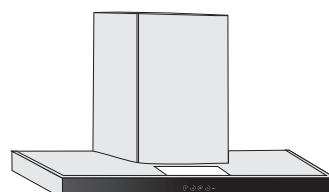

Remove the two screws on the switch cover plate and then rotate the cover plate to pull out the switch assembly for maintenance and replacement.

Note: Installation steps of the lights and switches are opposite to the removal steps.

Removal of filter mesh



Align the cross screwdriver with the screw hole and raise it upward forcibly meanwhile rotating it counter-clockwise about 120°, so as to remove the screw out of the cross slot of the exhaust fume collecting hood. Hold the bottom of the mesh with one hand, and remove the screw on the other side with the other hand by the cross screwdriver.



Hold the two screws on the filter mesh with both hands and pull it down to detach the two prongs inside from the filter mesh. Then pull the filter out as per the arrow direction to remove it.

Note: In case of installing the filter mesh, face the side with screw holes inwards.

Removal steps of the whole range hood

Removal steps

1. Pull out the plug;
2. Unscrew the four screws from the back of the main hood panel. Tilt the panel forward to a certain angle, and then pull it up forcibly;
3. Remove the drawing panel from the main hood panel;
4. Use a cross screwdriver to unscrew the fastening screws on the cover to remove the cover;
5. Unscrew the fastening screws on the retaining ring to remove the retaining ring;
6. Unscrew the cap clockwise and take out the impeller vertically;
7. Remove the oil cup and the filter mesh by means of removing the fastening screws with a cross screwdriver.

Installation steps are opposite to the removal steps.

(When you install the impeller, please add some lubricating oil on the shaft hole of it.)

Note: Step 3 is unnecessary if no drawing panel is installed.

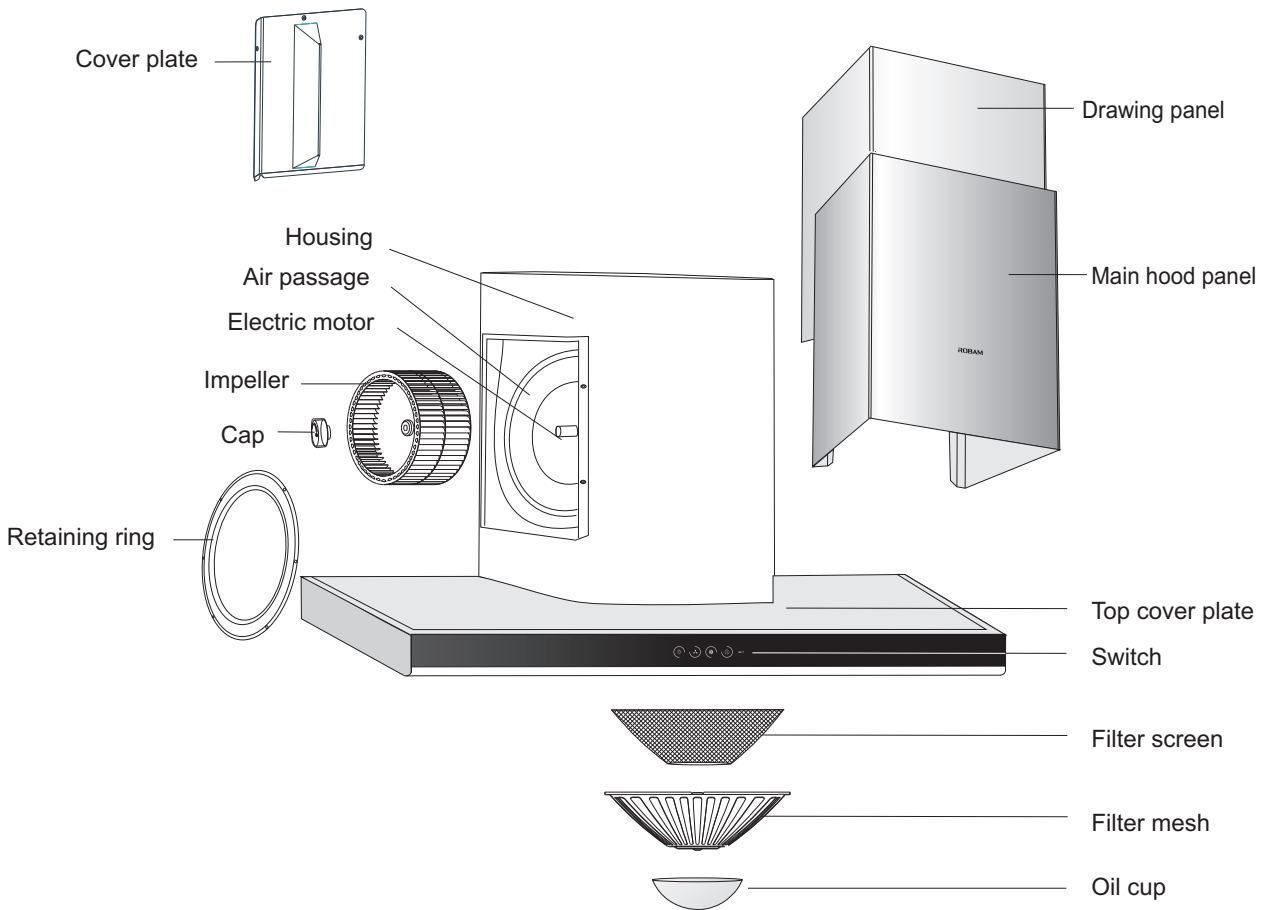

Circuit diagram

A817 Circuit Diagram

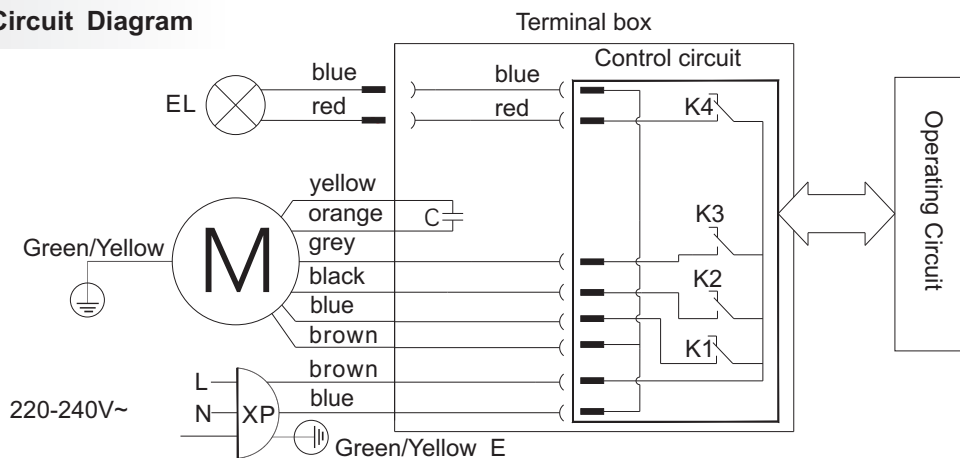

A815 Circuit Diagram

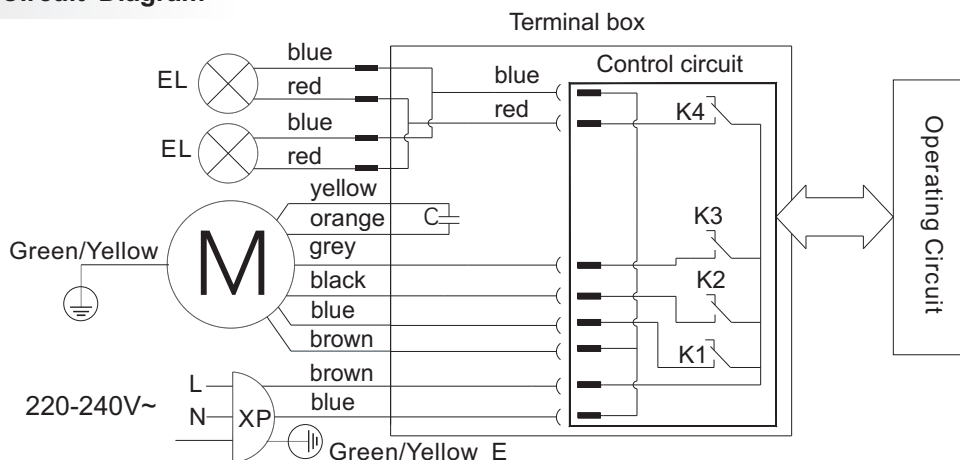

Troubleshooting of General faults

No.	Fault	Cause	⚠Warning
1	No response after pressing any button (e.g. the impeller does not rotate, or the light is off)	The power plug is not connected properly or there is power failure	1. When connecting or replacing the plug, please unplug the power plug. 2. If the range hood's power cords are damaged, it must be replaced by our company's professional maintenance staff. 3. The flame is strictly prohibited being sucked into the machine in case of the accidents.
2	Pressing the light switch, the light is not lit	The light is damaged or poorly connected	
3	Induced current exists on the hood body may paralyze hands	The power socket is not grounded well	
4	Abnormal sound during impeller running	The impeller is loose, and the cap is not tightened	
5	No oil in the oil cup after a period of time	The body is tilt	

Edition: A/2

Publication Date: May,15,2017

ROBAM